



SHEET METAL WORKING MACHINES  
**Manual**

# Sheet metal working machines

## Manual

BAM 2 m



ASK 3

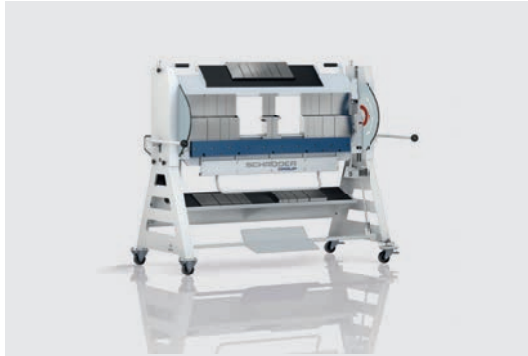

ASK II



AK



204



HS

Better sheet metal working – we have dedicated ourselves to enabling highest quality standards and efficient processes in the production of sheet metal products. This brochure can only give you an initial overview of our machines designed for thin sheet metal applications up to 4 mm steel sheet – we are pleased to offer you our advice to selecting a suitable machine for your requirements.

### 75 years of sheet metal working

Since 75 years Hans Schröder Maschinenbau GmbH specialized in the development of modern machine concepts for bending and cutting sheet metal for craftsmen and for industrial production processes. The family owned company founded in 1949 by Hans Schröder unifies traditional and modern approaches in machine building: technical competence and high commitment to innovation, intensive quality- and service orientation, the work for and with the customer as well as a trusting cooperation with suppliers and employees.

Modular 2 m



Modular 3 m

Working length	1,000	1,250	1,500	2,000	2,500	3,000
Sheet thickness (400 N/mm <sup>2</sup> )						
Manual folding machines						
0.75				BAM		
0.80	BAM			Modular		Modular
1.00				AK/ ASK II	AK/ HS	AK/ HS
1.25				HS		
1.50	ASK 3	ASK 3	ASK 3	AK		
1.75			ASK II			
2.00	ASK II / 204/ HS					

## Table of content

### Folding machines, manual

▪ BAM	4
▪ Modular	6
▪ AK	8
▪ ASK 3	12
▪ ASK II	16
▪ 204	18

### Shear, manual

▪ HS	20
------	----

Tools AK, ASK 3 and ASK II	22
----------------------------	----

# BAM

## Mobile folding machine for construction sites

The Schröder folding machines BAM is the classic in handicraft businesses and represents a reliable precision tool for the workshop and the construction site.



BAM 1000

BAM 2000

Cutting device

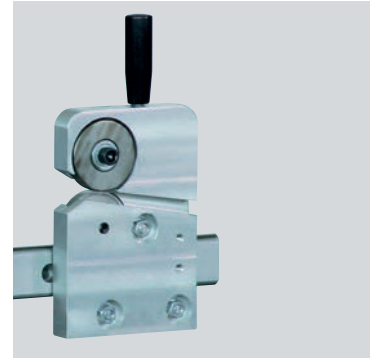

Back gauge- and sheet support system up to 500 mm (BAM 1000) or 750 mm (BAM 2000)

The BAM extends the range of sheet metal working machines produced by Hans Schröder Maschinenbau. It is small, light, but offers very high functionality and mobility.

### BAM 1000

- The quick rotating clamping beam is the highlight of the BAM. Sharp rail for standard and goat's foot for narrow bends complement each other, an option found otherwise only in a few CNC-controlled machines, e.g. the Schröder PowerBend Multi.
- The big clearances allow profiles, e.g. narrow U-bends, that are simply not feasible in other machines.

### BAM 2000

- Clamping beam: Sharp nose blade and radius blade are exchangeable
- Folding beam: Folding blade is exchangeable

### BAM 1000 and BAM 2000

- The cutting head slices neatly through the clamped sheet. The solid aluminium structure runs on the linear guide with almost no friction. The blades are adjustable and exchangeable.
- Optionally you can choose adjustable beading rods in 12 mm /14 mm or 16 mm with one set of twist clamps.



## Standard equipment

BAM 1000	BAM 2000
Quick rotating clamping beam with sharp blade and goat's foot blade for narrow bendings	Sharp nose blade 20°, exchangeable
Folding blade 15 mm	Folding blade 15 mm, exchangeable
Easy to assemble and transport	Folding beam adjustment for radius blades
Quick clamping beam	Folding beam with crowning device
Back gauge and sheet support system 500 mm	Back gauge and sheet support system 750 mm
-	Quick clamping beam with one-hand operation
-	Clamping beam with counterbalance adjustment
Cutting device incl. guide rail for max. sheet thickness 0,8 mm St37	
Bending angle indicator	
Stand with 4 castors: 2 fixed- and 2 steering castors, lockable	

BAM 1000:  
Rotating clamping beam



BAM 1000  
Bending result: narrow U-bend

## Special equipment

BAM 1000	BAM 2000
Adjustable beading device without beading rod and twist clamp	
Beading rod 12 / 14 or 16 mm and 1 set of twist clamp	

## Technical data

Type	BAM 1000 x 0.8	BAM 2000 x 0.75
Sheet thickn. in mm bei (400 N/mm <sup>2</sup> )	0.8	0.75
Working length (mm)	1,020	2,020
L x W x H (mm)	1,142 x 600 x 1,142	2,173 x 600 x 1,229
Weight with base frame (kg)	80	210
Clamping beam stroke (mm)	45	65

Disassembled, the BAM fits into any car boot, and assembly takes only a few minutes. When removing the base of the machine, the BAM can be placed on a workbench.



BAM 1000 with adjustable beading device

# MODULAR – folding machine for construction site

Exactly bent long profiles. MODULAR is the combinable, modular folding machine from Schröder that enables profiling any length of sheet metal – directly at the construction site or in workshops.



MODULAR 2000  
Basic module and extensions

Modular 3000

The cutting device cuts sheets exactly and quickly.

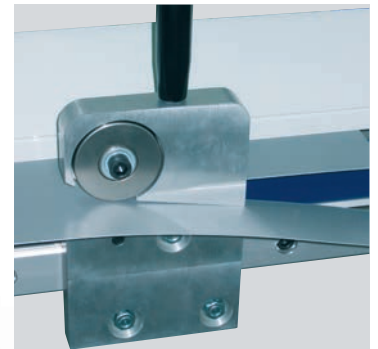

Option: 2 sheet supports with slot and 2 tipping gauges, 670 mm

The MODULAR folding machine was designed for the daily work processes of plumbers, thismiths, tilers, and roofers. The name says it all: Anyone who works with long sheets in the workshop or at the construction site can combine two or more sheet metal benders with just a few adjustments to produce a long folding machine. This modular folding machine is also very popular in many workshops: Rigid construction, adjustable rollers, low weight, and an optional cutting or multi-function head make it the ideal, versatile helper in any workshop and at any construction site.

It's the clever details that make MODULAR a valuable every day and specialized too:

- If required, the robust mobile individual devices can be connected to a long folding machine.
- Two horizontally movable gauge arms with T-slot, scale and tipping gauges bring the sheet in the correct position on a stable surface. This enables shets to be bent and cut quickly in exact repetition and a high degree of precision.
- Clearance: The huge clearances enable to profiles that would not be possible to bend on other machines.





One function of the cutting- and flattening device is to close folding edges

Standard equipment
2 000 mm or 3 000 mm working length per machine, suitable for line-up
Machine movable 4 or 6 steering castors, lockable
Bending angle one-sided, standard right
Inserting depth 670 mm over complete machine length
Free distance for 1,000 mm coil width
Increase of capacity and extended inserting depth on request
Special equipment
Gauge: 2 sheet supports with slot and 2 tipping gauges, 670 mm
2 additional tipping gauges
Guide rail
Cutting device for max. sheet thickness 0.8 mm St37
Cutting- and flattening device combined
Additional bending angle indicator

### Technical data

MODULAR	2,000 x 0.8*	3,000 x 0.8*
Capacity in mm at 400 N/mm <sup>2</sup>	0.8	0.8
Capacity in mm at 250 N/mm <sup>2</sup>	1.0 Cu	1.0 Cu
Clamping beam stroke mm	55	55
L x W x H mm	2,000 x 880 x 1,100	3,000 x 880 x 1,100
Weight kg	210	340

\*Available as basic modul or as extension modul (incl. connecting parts).

- Options: A very popular additional option is the cutting device or the multifunctional device. The multi-functional device combines cutting, profiling, and hemming device to cut, bead or stamp, and even to close folding edges precisely.

# AK – the classic workshop machine

The manual folding machine type AK is the classic workshop machine for the daily use in small and mid-sized businesses – simply indestructible and easy to operate.

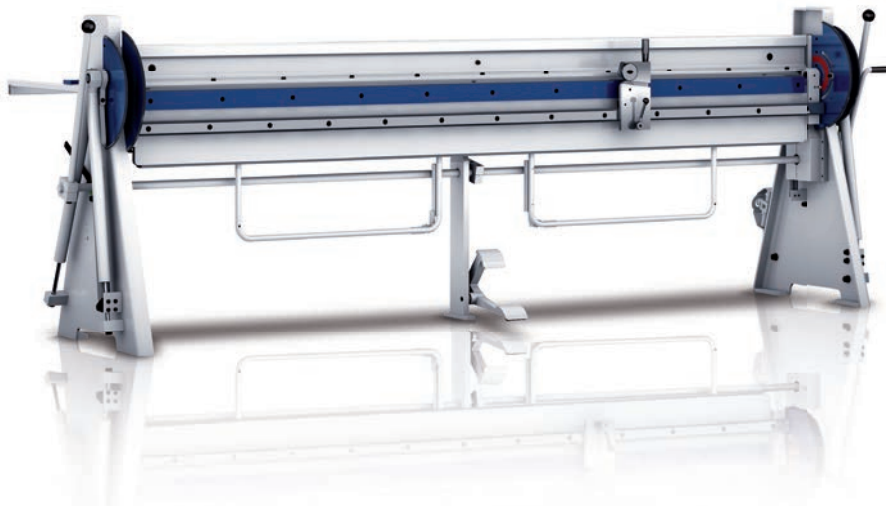

Ergonomic working height 930 mm and optimized pedal position



The pneumatic bending support is controlled by a finger lever on the folding beam handle.

The hand-operated folding machine AK is the perfection for everyday needs in small and medium enterprises. The manual folding machine from Schröder has been employed by plumbing, roofing, and sheet metal working firms at home and abroad for decades now.

The technically perfect and proven machine design stands for flexibility and profitability and, thanks to its maintenance and wear-free guides and machine elements, the AK is virtually indestructible in daily use.

With the extensive standard equipment, the Schröder AK is ideal for tackling any jobs that may come up.

## Basic features

- The folding beam made of universal mill plate is rigidly welded to a bending profile over the whole length.
- The clamping and bottom beams made of the S 54 special profile are break-proof and of high strength.
- The clamping beam slides on a special plastic covering, which ensures precise vertical and almost effortless operation by hand lever or pedal.
- The folding beam weight is telescopically balanced or compensated over the whole bending range.





Standard equipment	
Clamping beam	<ul style="list-style-type: none"> <li>- Tinsmith blade 22,5°, directly screwed, sharp, clearance 6 mm for hems, foot width 30 mm, ca. 700 N/mm<sup>2</sup></li> </ul>
Folding beam	<ul style="list-style-type: none"> <li>- Folding blades 10 and 25 mm (for AK 3 000: 15 and 25 mm)</li> </ul>
Bottom beam	<ul style="list-style-type: none"> <li>- Bottom beam blade, one-piece</li> <li>- Bottom beam blade with finger grooves, minimal gauge 6 mm</li> </ul>
Angle gauge	<ul style="list-style-type: none"> <li>- Adjustable angle gauge</li> </ul>
Others	<ul style="list-style-type: none"> <li>- Tool set</li> <li>- Working height 930 mm</li> <li>- Foot pedal to operate the clamping beam</li> </ul>

Special equipment	
Back gauge	<ul style="list-style-type: none"> <li>- Sheet support table incl. back gauge 6 - 750 mm, adjustable from the rear</li> <li>- Manual back gauge 6 - 750 mm, adjustable from the front with digital readout incl. sheet support table</li> <li>- Additional bending angle gauge</li> </ul>
Tool options	<ul style="list-style-type: none"> <li>- Folding blades 10 mm and 15 mm, ca. 700 N/mm<sup>2</sup></li> <li>- Radius blade R2/3/4/5, ca. 700 N/mm<sup>2</sup></li> <li>- Further tool options see page 22-23</li> </ul>
Others	<ul style="list-style-type: none"> <li>- Guide rail</li> <li>- Cutting device for max. sheet thickness 0,8 mm St37</li> <li>- Profiling- and flattening device</li> <li>- Pneumatic bending support</li> <li>- Adjustable beading device without beading rod and twist clamp</li> <li>- Beading rod 14/16/18/20 or 22 mm</li> <li>- Set of twist clamps</li> </ul>

# Technical data AK

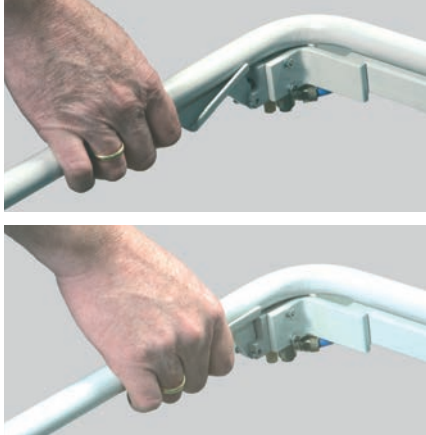

AK	2000 x 1,0	2000 x 1,5	2500 x 1,0	3000 x 1,0
Working length mm	2020	2020	2520	3020
Sheet thickness (400 N/mm <sup>2</sup> )	1,0	1,5	1,0	1,0
Weight basic machine (ca.)	715 kg	840 kg	945 kg	1060 kg
Outer dimensions				
(a)	2670		3170	3670
(b)	2222		2722	3222
(c)	225	275		
Back gauge with sheet support table adjustable from the rear (d)			765	
Back gauge with sheet support table adjustable from the front with digital readout (e)			805	

Pictures on the left: pneumatic bending support

## Pneumatic bending support

The pneumatic bending support is controlled by a finger lever on the folding beam handle. The pneumatic cylinder assists the operator in bending the piece. You only need a compressed air supply.

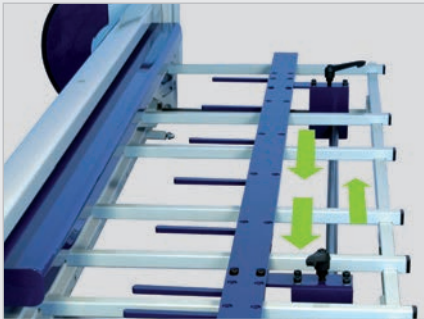

### Back gauge

The sheet support table incl. back gauge with its displaceable and removable supporting rails provides for highly variable working options.

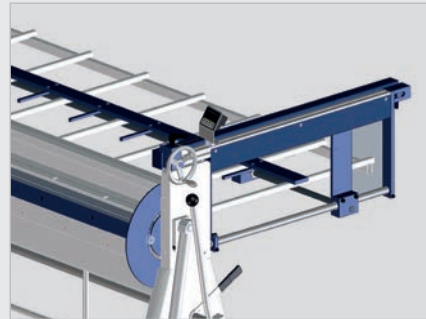

### Back gauge

Option: Manual back gauge adjustable from the front with digital readout incl. sheet support table.

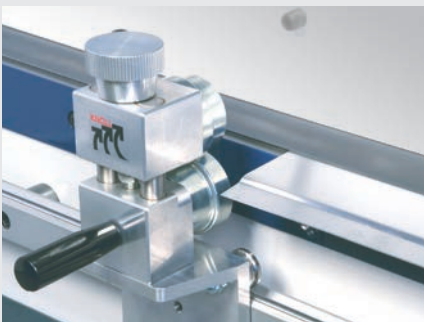

### Profiling- and flattening wheels

The profiling and flattening wheels are used to give the piece the required shape.



The cutting device is used for safe and easy cutting of the sheet.



### Beading device

Adjustable beading device without beading rod and twist clamp.

## Dimensions AK

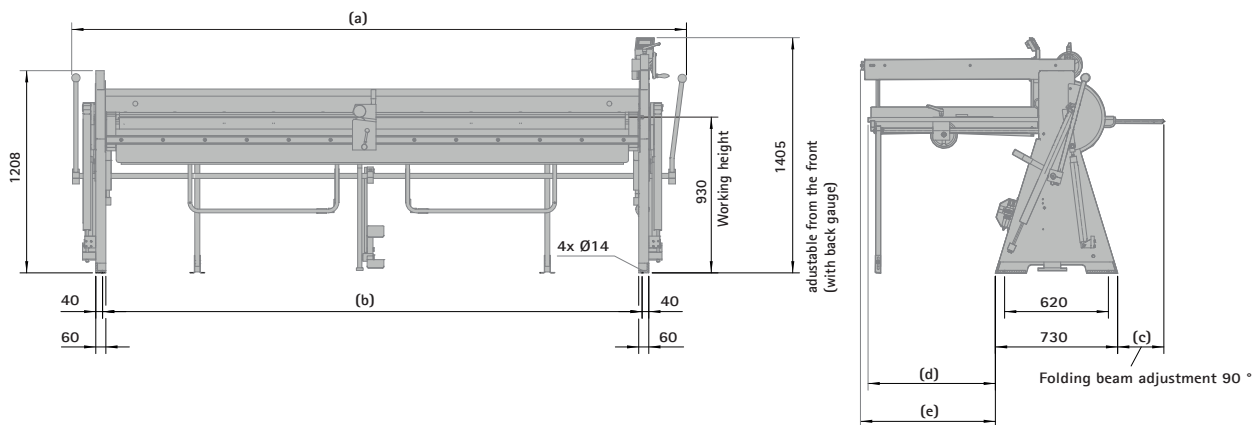

### Further basic features

- Angle scale for folding beam with movable angle gauge for series bends.
- Pedal with integrated center bearing for opening and closing the clamping beam. The center bearing gives additional stability to the bottom beam for hems.
- Eccentric drive for fast opening and closing and safe clamping of the parts.
- Clamping range shifted via two precision eccentric bushes integrated into the lateral frame and the center bearing.
- The clamping beam tools and bottom beam rails are fixed by guide bushings and are easy to exchange.
- All guides and machine elements are maintenance-free and resistant to wear.

# The segmented folding machine of the 3rd generation – ASK 3

For more than 60 years we have been supplying workshops with folding machines. They are part of the standard equipment in workshops and at construction sites and are considered as reliable precision tools.

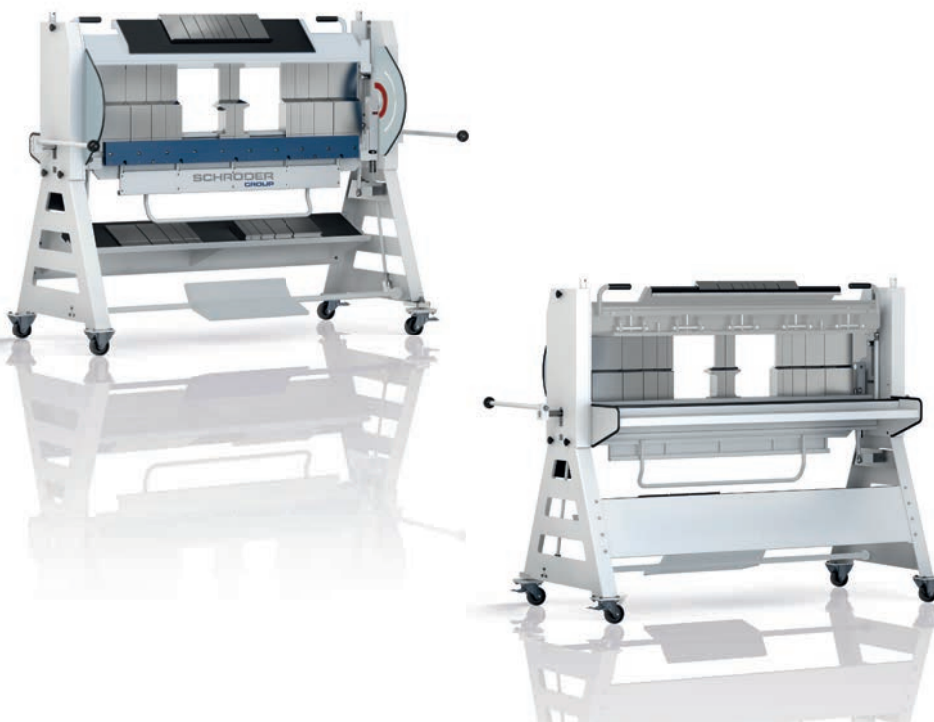

The ASK 3 is the flexible machine for real folding specialists.

Stand with depositing plate  
incl. tool storage function



Clamping beam with tool storage function

The popular folder ASK 3 replaced the previous model ASK and has been constructed based on decades of experience in manual folding machines that are aimed at workshops and construction sites. The ASK 3 is the improved flexible machine for real folding specialists: Segmented tools on all beams allow larger clearances for complex work pieces.

It's the design details that make the ASK 3 a valued everyday tool in craftsmen's workshops:

- The quick tool clamping with an eccentric drive on the clamping beam and the folding beam increases precision and the clamping force. It can be opened and closed with one simple move – this reduces set-up times towards zero.
- The multi-stage drive of the clamping beam enables the use of various tool heights..
- Free space: up to 180 mm at the clamping beam, up to 120 mm at the bottom beam and up to 142 mm at the folding beam.

**These large tool clearances extend your product range enormously and increase your flexibility.**



Standard equipment
Patented quick clamping device with eccentric for quick changing of clamping and folding beam tools
Multi-stage clamping beam drive for four different tool heights
Goat's foot blade, 130 mm high, 30°, sharp, clearance 26 mm, foot width 41 mm, free space 110 mm, segmented incl. corner parts, ca. 700 N/mm <sup>2</sup>
Bottom beam blade, free space 55 mm, segmented incl. corner parts, ca. 700 N/mm <sup>2</sup>
Combi-folding blade, 120 mm high, 12/15 mm, free space 77 mm, segmented incl. corner parts, ca. 700 N/mm <sup>2</sup>
Tool segmentation for 1,000 mm: 30/50/70/100/150/200/300 mm plus 2 x 75 mm corner parts, with 1,250 mm lengths plus 250 mm segments, with 1,500 mm length plus 2 x 250 mm segments
Foot pedal for opening and closing of clamping beam
Clamping beam stroke 110 mm
Clamping beam with tool storage function
Stand with depositing plate incl. tool storage function
Bending angle indicator
Bending angle gauge
Stacking table for tools
Machine on 4 castors: 2 fixed and 2 steering castors, lockable (steering castor height-adjustable with handle front side right)
Special equipment
2 variable gauge arms, 600 mm with scale, movable on linear guide incl. 2 tipping gauges
1 pair additional tipping gauges
Additional bending angle gauge
Corrosion protection zinc-phosphated for one complete tooling set
Surface-hardened folding beam- and bottom beam blade (recommended for stainless steel applications)
Tool case
Cutting device incl. linear guide for max. sheet thickness 0,8 mm St37 (Only for standard folding beam heights)
2 additional steering castors (fixed castors in standard dropped)
Folding beam and bottom beam lowered with tools, ca. 700 N/mm <sup>2</sup> : - Folding beam opening 142 mm, width 17 mm - Bottom beam opening 120 mm, width 45 mm (Only possible to order ex works!)
Tool set to form window sills suitable for tool height: clamping beam 130 mm/170 mm/200 mm folding beam standard or lowered
For further tools please see page 22-23

# Technical data ASK 3

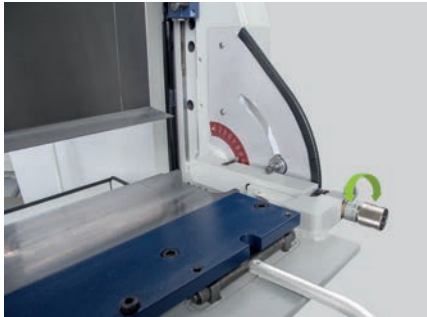

Folding beam adjustment

ASK 3	1,000 x 1.5	1,250 x 1.5	1,500 x 1.5
Working length	1,050 mm	1,300 mm	1,550 mm
Sheet thickn. (400 N/mm <sup>2</sup> )	1.5 mm	1.5 mm	1.5 mm
Weight	310 kg	350 kg	390 kg
Dimension L/W/H	1,613/885/1,387 mm	1,863/885/1,387 mm	2,113/885/1,387 mm
Folding beam lowering	15 mm		
colour	RAL 7035 light grey, RAL 5003 sapphire blue		



## Smooth gauges

The freely positionable sheet support- and gauge arms are constructed in a way that they can easily be moved and fixed. The sheet support arms can easily be manipulated from the operator side. Hence, unnecessary walking routes around the machine can be avoided.



## Clamping beam force adjustment

Furthermore improved is the adjustment of the clamping force and the folding beam. They can be adjusted now with knurled screws without any additional tools.



## New gauge for the bending angle

A very practical feature is the new, push-back gauge for the bending angle. This means that the operator can keep an angle gauge adjustment and can nevertheless e.g. hem a flange. The gauge can easily be pushed in so that the folding beam is free.

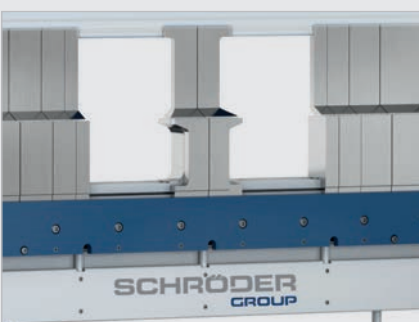

## Bigger clearances create opportunities

Segmented tools on all beams provide bigger clearances for complex work pieces. Now the operator has the option to use four different tool heights. With the goat's foot tools he has extended free space available. Using the sharp nose blade he has clearances for bends up to 135° - also with longer sides.



## Cross section: ASK 3

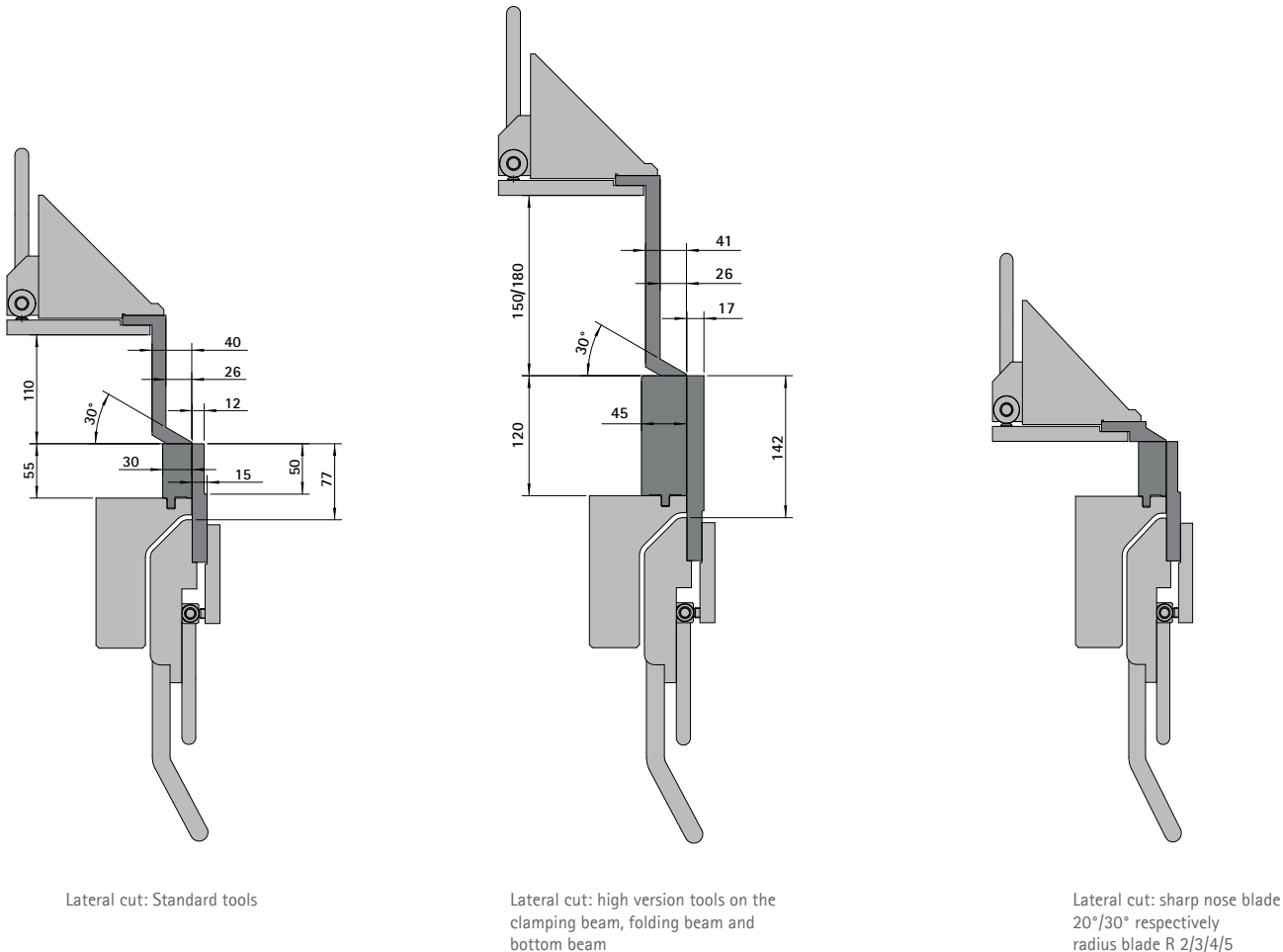

The ASK 3 is available in the version 1,000 mm, 1,250 mm and 1,500 mm.

This machine that is popular amongst plumbers since many years has also been improved in several points regarding its handling.

Thus, not only was the positioning of the tool case adjusted to the ergonomics but also the foot pedal for a fast opening and closing of the clamping beam has been reengineered. Thanks to a much bigger clamping beam stroke, it is now much more comfortable to manipulate sheets for clamping.

# ASK II – Top quality standard equipment

The ASK II is our popular segment folding machine for craftsmen – proven thousands of times in workshops and the construction site.

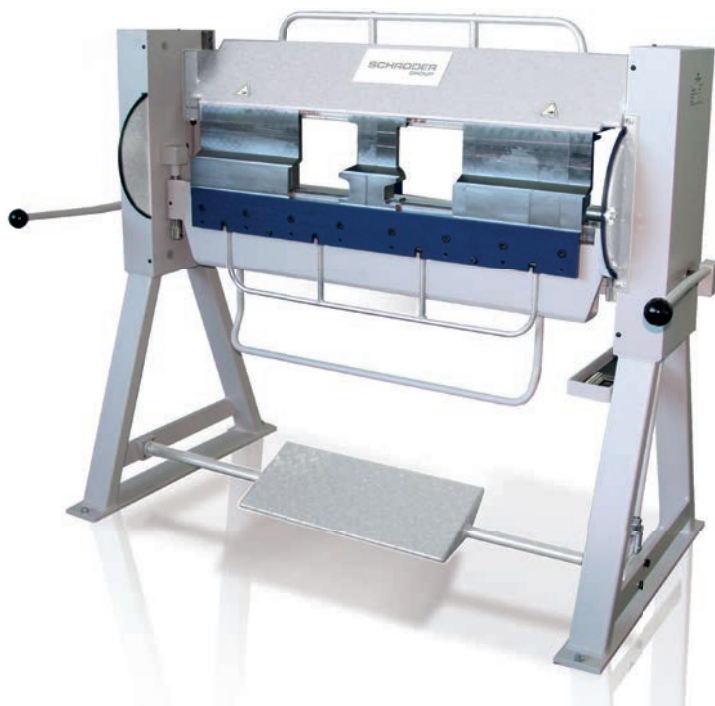

ASK II

Variable gauges for precise results

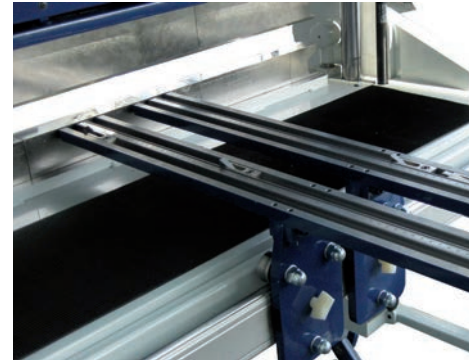

Patented quick clamping device with eccentric for clamping- and folding beam

The segmented folding machine is a part of the standard equipment of every sheet metal processing workshop – in this case, a high-quality ASK II from Schröder is a purchase for life. Robust enough for tough everyday work, yet easy to use and flexible in terms of its applications.

It's the design details that make the ASK II a valued everyday tool in craftsmen's workshops.

- The patented quick clamping device with eccentric on the clamping beam and the folding beam increases precision and clamping force. It can be opened with only one single manual action – this reduces setup times to near-zero.
- The multi-stage drive of the clamping beam allows using various tool heights. Segmented tools on the clamping beam, bottom beam and folding beam provide free space for bending complex pieces.
- High-performance folding made possible by the enhanced design and frame-guided clamping beam.
- Additional processing step included: sheets are cut exactly and quickly with a special cutting device.
- Two sliding gauge arms with scale and two T-slots put the sheet in a stable and exact position.
- Pneumatic springs enable dynamic mass balancing.

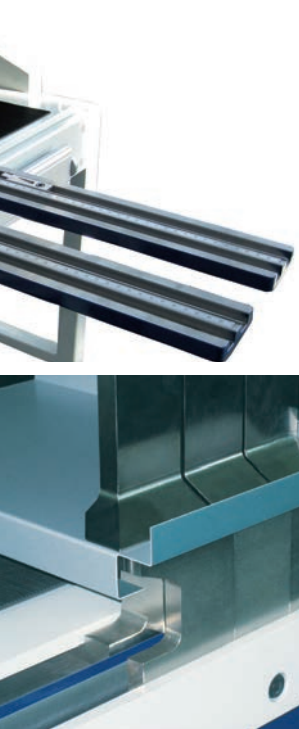

Segmented tools on all three beams create new possibilities.

Standard equipment
Patented quick clamping device with eccentric for quick changing of clamping and folding beam tools
Two-stage clamping beam drive for two different tool heights
Goat's foot blade, 130 mm high, 30°, sharp, clearance 26 mm, foot width 41 mm, free space 110 mm, segmented incl. corner parts, material strength 700 N/mm <sup>2</sup>
Bottom beam blade, segmented, connector system with corner parts, 700 N/mm <sup>2</sup>
Folding blade 15 mm, segmented incl. corner parts, 700 N/mm <sup>2</sup>
Segmentation of tools for 1,000 mm: 30/50/70/100/150/200/300 mm + 2 x 75 mm corner parts plus 250 mm segments for larger lengths
Clamping beam stroke 110 mm
Bending angle indicator
Foot pedal for opening and closing the clamping beam

Special equipment
2 variable gauge arms 750 mm with 2 T-slots and scale, movable on linear guide incl. 2 tipping gauges for insertion in T-slot
2 additional tipping gauges
Bending angle gauge
Goat's foot blade, hardened, 130 mm high, 30°, R 1/2/3/4, clearance 30 mm, foot width 50 mm, free space 110 mm, segmented incl. corner parts, 1100 N/mm <sup>2</sup>
Sharp-nose blade 20° and/or 30°, sharp
Radius blade R2/3/4/5
Folding blade and bottom beam blade, surface-hardened (recommended for stainless steel applications)
Tool set to form window sills
Machine with castors: 4 steering castors, lockable
Tool case
Cutting device incl. linear guide for max. sheet thickness 0.8 mm St37

### Technical data

ASK II	1,000 x 2.0	1,500 x 1.75	2,000 x 1.0
Capacity in mm at 400 N/mm <sup>2</sup>	2.0	1.75	1.0
Working length mm	1,050	1,550	2,050
Stages	2	2	2
L x W x H mm	1,540 x 750 x 1,265	2,040 x 750 x 1,265	2,540 x 750 x 1,265
Weight kg	515	600	740

# The manual folding machine 204

The manual folding machine type 204 is the frontrunner in the handicraft business: It is a must in workshops, in sample construction and in repair shops.



The small folder with big highlights.

204	10/2
Working length (mm)	1,020
Sheet thickness (400 N/mm <sup>2</sup> )	2.0
Machine length (mm)	1,760
Machine width (mm)	360
Machine height (mm)	1,320
Clamping beam stroke (mm)	220
Folding beam adjustment (mm)	60
Bottom beam adjustment (mm)	
Weight (kg)	460



Combined spring finger and back gauge with scale, rack and pinion

The favourite in handicraft: essential in workshops, sample construction and repair shops.

## Clamping beam

- Sufficient stroke height for different tool geometries
- Drive with handwheel and bevelled gears
- Short change-over time by quick clamp system for tools
- Space for flanged parts

## Folding beam

- Adjustable for exact radius bending
- Adjustable angle gauge for identical bending angles
- Folding beam supported by gas spring

## Bottom beam

- Adjustable via radius tools

## Standard equipment

- Sharp-nose blade „SA“ 45° (WZS 1000), ca. 700 N/mm<sup>2</sup>
- 2 folding blades consisting of:
  - 10 mm flat blade and
  - 17 mm carrier blade
- Folding beam- and bottom beam adjustment 60 mm
- Adjustable angle gauge
- Clamping beam stroke 220 mm

## Special equipment

- Pneumatic bending support
- Manual back gauge HAH 21
  - Combined spring finger- and back gauge with scale, rack and pinion, adjustment range 0 - 600 mm
- Segmentation of bottom- and folding beam possible
- Different tool options available



Pneumatic bending support

**Standard equipment tools**

Clamping beam tools WZS 1000 ca. 700 N/mm<sup>2</sup>

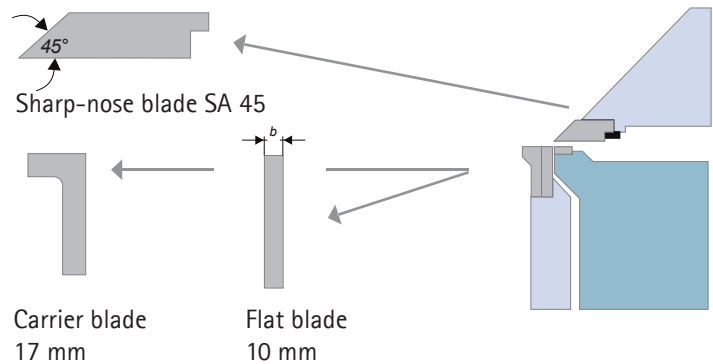

**Standard equipment tools**

Clamping beam tools WZS 1000 ca. 700 N/mm<sup>2</sup>

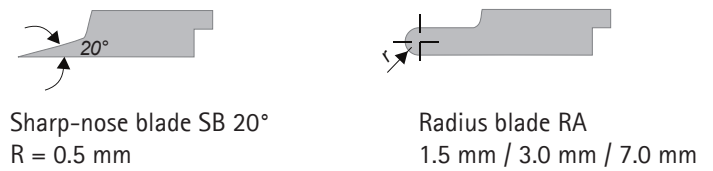

**Mechanic tool clamping device for goat's foot segments „KA“**

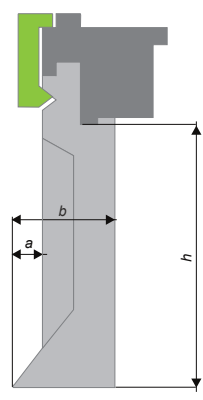

Goat's foot segments KA  
grid dimension 5 mm from 25 mm  
a = 11 mm  
b = 41 mm  
h = 60 mm or 120 mm

Segmentation of tools for 1,020 mm:  
3x25/2x30/2x35/3x40/45/50/2x100/2x200



**Bottom beam**

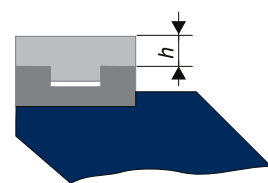

**Folding beam**

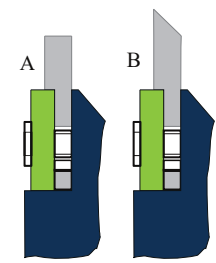

# HS - the effort-saving manual shear

The eccentric shear HS will be used for nearly all cutting requirements. Ridge-free, distortion-free and nearly burr-free cuttings are the typical characteristics of this shear.

HS

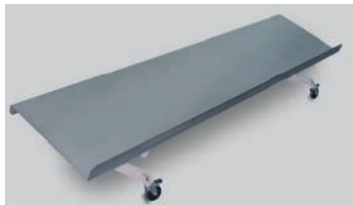

Sheet shute on wheels with 4 steering castors, 2 lockable.



Manual back gauge with scale and handwheel adjustment [6] on the angle guides [5] for parallel and conical cuts.

## Standard - Modell HS

Experience gathered over decades is reflected in the technology and design of this shear, which is capable of cutting almost any metal and non-metal materials. With the aid of new design techniques, we are able to offer a tried and tested product incorporating state-of-the-art technology.

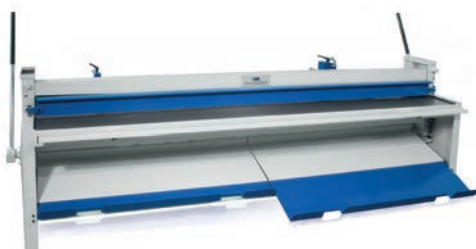

Telescope sheet shute incl. stacking function

## Basic design

- Torsion-free rigid welded construction. Compact and well laid-out machine construction.
- Standard double-edged upper and lower blades of quality steel guarantee clean cuts without burrs for years to come.
- The low-friction overhead drive running in roller bearings ensures advantageous application of the levers.
- Flat cutting beam guides with robust and wear-resistant special sliding cover.







6



### Standard equipment HS

Telescopic support table [1]
Angle gauge, left and right with inlaid scale [2]
Milled grooves every 10 mm along the table, parallel to the blades [3]
Hold-down device with hard rubber rail to protect polished sheets [4]
Manual back gauge 500 mm [6]
All-steel blade, double-edged

### Special equipment

Back gauge	<ul style="list-style-type: none"> <li>- Manual back gauge 750 mm</li> <li>- Manual back gauge 750 mm adjustable from the front with digital readout</li> <li>- Mechanical sheet support for manual back gauge 750 mm without sheet shute</li> </ul>
Blades & Others	<ul style="list-style-type: none"> <li>- Blades designed for stainless steel, instead of standard blades</li> <li>- Sheet shute to the front</li> <li>- Telescope sheet shute incl. stacking function</li> <li>- Sheet shute on wheels, 4 steering castors, 2 lockable (for cuttings up to max. 500 mm, up to max. 200 kg)</li> </ul>

Maße: HS

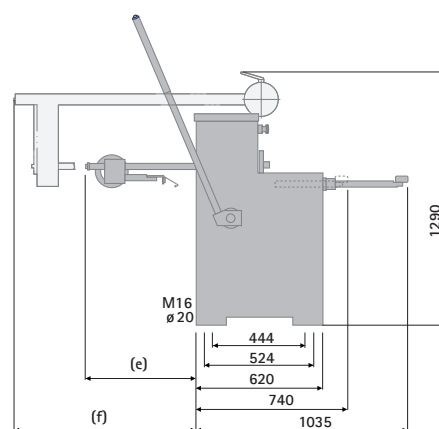
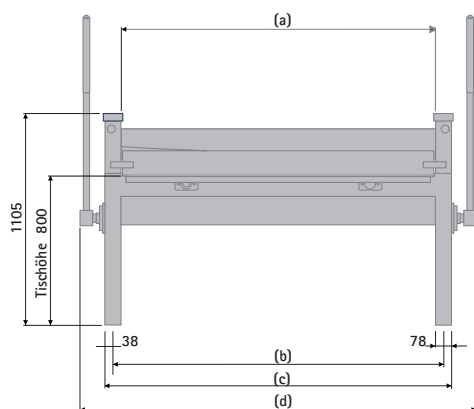





Optional: Mechanical sheet support for manual back gauge 750 mm without sheet shute.

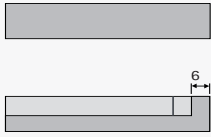
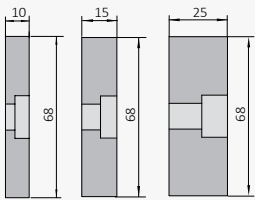

Optional: Manual back gauge 750 mm adjustable from the front with digital readout

Technical data	1,000 x 2.0	2,000 x 1.25	2,500 x 1.0	3,000 x 1.0
Work. length/Cutting length (a)	1,030 mm	2,030 mm	2,530 mm	3,030 mm
Sheet thickness 400 N/mm <sup>2</sup>	2.0 mm	1.25 mm	1.0 mm	1.0 mm
Cutting angle	4.0°	2.2°	1.8°	1.5°
Weight	485 kg	660 kg	775 kg	920 kg
Outer dimensions				
(b)	1,120 mm	2,120 mm	2,620 mm	3,120 mm
(c)	1,196 mm	2,196 mm	2,696 mm	3,196 mm
(d)	1,440 mm	2,440 mm	2,940 mm	3,440 mm
Machine width				
Back gauge, manual 500 mm (e)	540 mm			
Back gauge, manual 750 mm (e)	790 mm			
Back gauge, manual, adjustable from the front 750 mm (f)	860 mm			

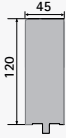
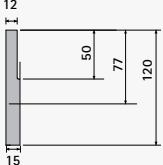
# Tools AK, ASK 3 and ASK II

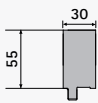
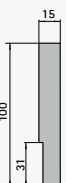
Bottom beam tools	Folding beam tools
<b>AK</b>	
<p>Standard</p> <p><i>Bottom beam tools WZS 220</i> ca. 700 N/mm<sup>2</sup></p> <ul style="list-style-type: none"> <li>Bottom beam blade one-piece</li> <li>Bottom beam blade 6 mm for finger gauge</li> </ul> 	<p>Standard</p> <p><i>Folding beam tools WZS 100</i> (only for manual clamping), ca. 700 N/mm<sup>2</sup></p> <ul style="list-style-type: none"> <li>Folding blades 10 and 25 mm (For WL 3000: 15 and 25 mm)</li> </ul> 
<b>ASK 3</b>	
<p>Standard</p> <p><i>Bottom beam tools WZS 200</i> ca. 700 N/mm<sup>2</sup></p> <ul style="list-style-type: none"> <li>Bottom beam blade free space 55 mm, segmented incl. corner parts</li> </ul>  <p>Option</p> <p><i>Bottom beam tools WZS 200</i> ca. 700 N/mm<sup>2</sup> or 1100 N/mm<sup>2</sup></p> <ul style="list-style-type: none"> <li>Free space 120 mm, width 45 mm, for lowered bottom beam (only possible to order ex works!)</li> </ul> 	<p>Standard</p> <p><i>Folding beam tools WZS 121</i> ca. 700 N/mm<sup>2</sup></p> <ul style="list-style-type: none"> <li>Combi-folding blade, 120 mm high, 12/15 mm, free space 77 mm, segmented incl. corner parts</li> </ul>  <p>Option</p> <p><i>Folding beam tools WZS 121</i> ca. 700 N/mm<sup>2</sup> or 1100 N/mm<sup>2</sup></p> <ul style="list-style-type: none"> <li>Free space 142 mm, width 17 mm, for lowered folding beam (only possible to order ex works!)</li> </ul> 
<b>ASK II</b>	
<p>Standard</p> <p><i>Bottom beam tools WZS 200</i> ca. 700 N/mm<sup>2</sup></p> <ul style="list-style-type: none"> <li>Bottom beam blade free space 55 mm, segmented incl. corner parts</li> </ul> 	<p>Standard</p> <p><i>Folding beam tools WZS 120</i> ca. 700 N/mm<sup>2</sup></p> <ul style="list-style-type: none"> <li>Folding blades 15 mm</li> </ul> 

## Clamping beam tools

### Standard

Clamping beam tools WZS 040  
directly screwed, ca. 700 N/mm<sup>2</sup>

- Tinsmith blade  
22,5°, sharp,  
clearance 6 mm for hems,  
foot width 30 mm

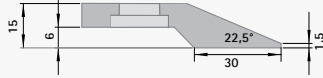

### Option

Clamping beam tools WZS 040  
(only for manual clamping), ca. 700 N/mm<sup>2</sup>

- Radius blade R2/3/4/5

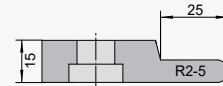

### Standard

Clamping beam tools WZS 012  
ca. 700 N/mm<sup>2</sup>

- Goat's foot blade  
130 mm high, 30°, sharp,  
clearance 26 mm, foot width 41 mm,  
free space 110 mm,  
segmented incl. corner parts

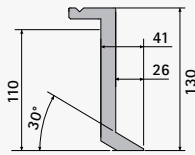

### Option

Clamping beam tools WZS 012  
ca. 700 N/mm<sup>2</sup>

- Goat's foot blade  
170 or 200 mm high, 30°, sharp,  
clearance 26 mm, foot width 41 mm,  
free space 150 or rather 180 mm,  
segmented incl. corner parts  
s = 1,25 mm

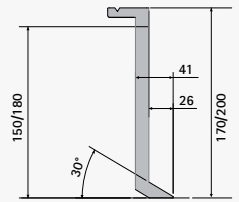

### Option

Clamping beam tools WZS 010, ca. 700 N/mm<sup>2</sup>

- Sharp-nose blade 20°/30°, sharp

- Radius blade R 2/3/4/5

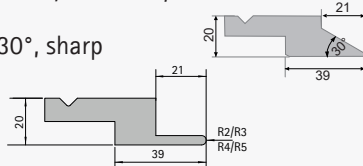

- Tool set to from window sills  
suitable for tool height clamping beam 130/170 or 200 mm and  
folding beam standard

Clamping beam tools WZS 010

segmented incl. corner parts, hardened ca. 1100 N/mm<sup>2</sup>

- Goat's foot blade  
130 mm high, 30°,  
R 1/2/3/4,  
clearance 30 mm,  
foot width 50 mm,  
free space 110 mm

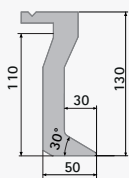

- Goat's foot blade  
170 mm high, 30°,  
R 1/2/3/4,  
clearance 30 mm,  
foot width 50 mm,  
free space 150 mm,  
s = 1,25 mm

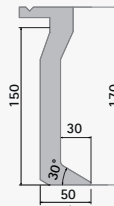

- Goat's foot blade  
200 mm high, 30°,  
R 1/2/3/4,  
clearance 30 mm,  
foot width 50 mm,  
free space 180 mm,  
s = 1,25 mm

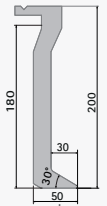

### Standard

Clamping beam tools WZS 012  
ca. 700 N/mm<sup>2</sup>

- Goat's foot blade  
130 mm high, 30°, sharp,  
clearance 26 mm,  
foot width 41 mm,  
free space 110 mm,  
segmented incl. corner parts

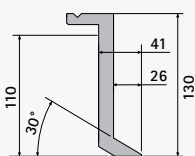

### Option

Clamping beam tools WZS 010  
ca. 700 N/mm<sup>2</sup>

- Goat's foot blade  
130 mm high, 30°,  
R 1/2/3/4,  
clearance 30 mm,  
foot width 50 mm,  
free space 110 mm

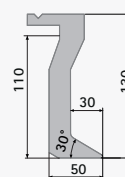

- Sharp-nose blade 20°/30°, sharp

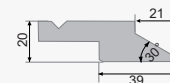

- Radius blade R 2/3/4/5

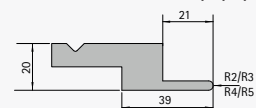



## Schröder Group

The Schröder Group consists of Hans Schröder Maschinenbau GmbH, which is located in Wessobrunn, Germany, SCHRÖDER-FASTI Technologie GmbH, located in Wermelskirchen, Germany and the SMU GmbH, located in Leinburg-Weißenbrunn.

Founded in 1949, Hans Schröder Maschinenbau GmbH unifies traditional and modern approaches in machine building: Successfully managed as a quality and customer-oriented, family-owned company, Hans Schröder Maschinenbau is specialized in the development of modern machine concepts for bending and cutting sheet metal.

The successful integration of the Fasti Company in 2006 and its worldwide presence make the Schröder Group one of today's leading providers of machines for bending, cutting, beading, flanging, and circular bending all types of sheet metal. The company's precision machines range from proven solutions for craftsmen to innovative, high-performance machines for automatic industrial production processes. 2021 the Schröder Group was expanded by the tool manufacturer SMU GmbH. Overall, the Schröder Group currently employs more than 300 people at various locations at home and abroad.

All information provided as a guide only  
and subject to change at all times.  
HSM 240201EN

Hans Schröder Maschinenbau GmbH  
Feuchten 2 | 82405 Wessobrunn-Forst | Germany  
T +49 8809 9220-0 | F +49 8809 9220-700  
E [info@schroedergroup.eu](mailto:info@schroedergroup.eu)  
[www.schroedergroup.eu](http://www.schroedergroup.eu)



Follow us on Instagram:  
[www.instagram.com/schroedergroup/](https://www.instagram.com/schroedergroup/)



Follow us on Facebook:  
[www.facebook.com/schroedermaschinenbau/](https://www.facebook.com/schroedermaschinenbau/)



Follow us on YouTube:  
[www.youtube.com/user/SchroederGroup](https://www.youtube.com/user/SchroederGroup)

**SCHRÖDER**  
GROUP